

LA TECNOLOGIA DEL VUOTO APPLICATA AL MONDO ALIMENTARE
THE BEST VACUUM TECHNOLOGY APPLIED TO THE FOOD PACKAGING



MADE IN ITALY

SIRMAN

AMAZING DESIGN



Moderno ed esclusivo
si adatta ad ogni ambiente

Perfetta ergonomia
per un miglior posizionamento prodotto

Ottima visibilità

Facile pulizia

Exclusive and modern design
adapts to any location

Perfect ergonomics
for an easy positioning of the products

Optimum visibility on the chamber

Absolute easy cleaning



COMPACT

Massimo rapporto tra **superficie utile** e ingombro macchina in ogni taglia.

Il profilo estremamente basso **si adatta a tutti i piani di lavoro** senza necessità di ingombranti e poco pratici carrelli dedicati.

*Maximum relationship between **usable surface** and counterspace need.*

*The low profile design **adapts to any working table** without the need of dedicated space demanding carts.*



CAMPANA

// DOME

Svilupa insieme sia il contenimento della campana che l'altezza della vasca. Come se su di una macchina tradizionale si potessero alzare anche i fianchi della vasca.

The high volume dome is designed to give all the space you need and get the best comfort, same as if you could lift even the sides of your chamber.



Supporto campana con **ammortizzatori** per evitare sollecitazioni.

*Domes are supported by rubber **bumpers** to avoid stress to the joints while under pressure.*



BARRE SALDANTI

// SEALING BARS



BARRA SALDANTE SINGOLA
SINGLE SEALING BAR



DOPPIA BARRA SALDANTE W8 50 DB
DOUBLE SEALING BAR W8 50 DB



TRIPLA BARRA SALDANTE W8 70 TB
TRIPLE SEALING BAR W8 70 TB



Barra saldante facilmente rimovibile per la pulizia.

Sealing bar easily removable for cleaning and sanitizing procedure.



Perfetta saldatura da 5 mm di spessore, in tempi ultrarapidi, grazie ai trasformatori a granuli orientati da 100VA.

Perfect 5 mm thick sealing system thanks to grain oriented 100VA powerful transformers.



Barra saldante con taglio

Optional sealing bar with cut-off wire

DISPLAY E COMANDI

// DISPLAY AND CONTROLS

Comandi estremamente semplici e intuitivi sia nella versione EASY TOUCH che nella versione TOP

Tastiera comandi touch capacitiva che garantisce un' **ottima durata nel tempo** della funzionalità di ogni tasto.

Semplice e immediato il display permette un'ottima visibilità su ogni fase della lavorazione e utilizzo.

Logica di controllo e **gestione della manutenzione.**

WiFi integrato che permette di controllare ogni versione tramite una pratica APP.

Intuitive and easy controls, both on the EASY TOUCH and on the TOP version

*The capacitive touch control ensures **perfect durability and functionality through the years.***

Simple but immediate the bright display offers great visibility during any use and working phase.

*The proprietary internal software helps to perfectly manage any **maintenance procedure** to get always the best performance from the pump.*

*The **integrated WiFi** chip allows an easy and total control from a free available APP.*



PROGRAMMI DEDICATI

// DEDICATED PROGRAMS



AUTOMATIC SENSOR
000% 0.0 Off

Ampia disponibilità di programmi per utilizzare al meglio la tecnologia del vuoto:

- Programma vuoto automatico a sensore sia per buste che per contenitori esterni
- Impostazione **sensibilità sensore** vuoto (10-5-1Mb)
- Programma dedicato ai **liquidi**
- Programma dedicato alla **marinatura**
- **10 programmi customizzabili** a piacere dell'utente
- Programma **riscaldamento /pulizia olio**
- **Opzione GAS ATM** per l'impacchettamento di prodotti delicati

A choice of different programs to get the best from vacuum technology:

- *Automatic Sensor Vacuum usable both for bags and external containers*
- *Adjustable vacuum **sensor accuracy** (10-5-1Mb) for an extreme vacuum precision*
- *Dedicated program for **liquids***
- *Dedicated program for **marinating***
- ***10 programs** savable to preference*
- ***Oil Cleaning/Heating** program*
- ***Gas flush option (MAP)** to gently pack any delicate food*



AOR[®]

AUTOMATIC OIL REPLACEMENT
PATENTED

Garantisce un utilizzo della macchina per anni senza necessità di manutenzione. Un brevetto esclusivo Sirman, unico al mondo.

Unique patented system by Sirman ensures perfect pump maintenance through the years.

SIRMAN



OPTION

SANO₃

AUTOMATIC OZONE SANITIZATION

Sistema brevettato sanificazione a Ozono

Patented Ozone based self sanitizing cycle

L'Ozono è un gas naturale che vanta una grande capacità ossidante in grado di eliminare germi, batteri e virus e grazie a questa caratteristica è in grado di igienizzare, combattere cattivi odori e muffe. Il programma brevettato **SanO₃**, automaticamente sanifica e deodora tutta l'area interessata all'aspirazione, dalla camera all'ultimo condotto interno, garantendo massima igiene sulla macchina e quindi sulle lavorazioni che vi vengono effettuate.

Un potente modulo da 28 g/h converte l'ossigeno in Ozono e ne riesce a creare in pochi secondi una concentrazione sufficiente a sterilizzare perfettamente, senza intaccare o compromettere gli organi interni della macchina. A fine programma l'Ozono decade naturalmente e diventa nuovamente ossigeno. **Un trattamento perfetto: semplice, economico, efficace e non residuale. Una esclusiva di SIRMAN.**

*Ozone is a natural gas with great oxidizing properties that kills germs, bacteria and viruses and thanks to this property can sanitize and beat bad smells and mold. The patented program **SanO₃**, automatically sanitizes and deodorizes the chamber, and every single pipe involved in the vacuum process, ensuring the best hygiene on the machine and therefore on the processed food.*

*A powerful 28g/h ozone module converts oxygen into ozone in a few seconds with a concentration which perfectly sterilizes without compromising the machine components. At the end of the program the ozone naturally converts back into oxygen. **A perfect treatment: efficient, economic, effective and non residual.***

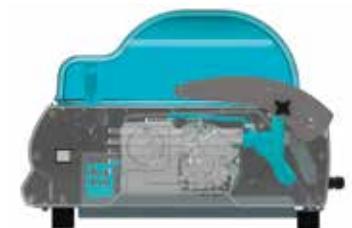

MANUTENZIONE

// MAINTENANCE

Estrema facilità di accesso a tutti i componenti per una **manutenzione veloce ed economica** (apertura a cofano).

Il **software** proprietario **gestisce la manutenzione ordinaria e straordinaria in modo predittivo** così da evitare inutili fermi macchina e ridurre i costi di gestione.

Extremely easy access to all components for a **fast and economic maintenance** (car hood system).

The proprietary internal **software** advises about all the **ordinary and extraordinary maintenance** procedures in order to avoid any problems and reduce the cost of ownership.



BUSTE

// VACUUM BAGS

SIRMAN



Possibilità di saldare **più buste sovrapposte**.

*Thanks to the high capacity transformer, **more overlapped bags** can be sealed at once to speed intense work load.*



Utilizzo di **buste goffrate** per il vuoto fuori campana.

***Embossed bags** can be used to seal bigger products holding them outside the lid.*



ACCESSORI

// VACUUM ACCESSORIES



Scivolo per l'utilizzo di buste con liquidi di serie. / **Standard support** for bags with liquid.

STANDARD



Opzioni gas inerte, A.T.M. solo su versione TOP / **Gas flush (MAP)** option available on TOP models.

OPTION



Stampante integrata opzionale solo su versione TOP. / **Optional printer** available on TOP models.

OPTION



Ripiano in plexiglass opzionale.
Optional plexiglass support for thin products.

OPTION



Cavalletto alluminio opzionale con e senza ruote disponibili per tutti i modelli h.757 + h.110 mm con ruote.

Anodized aluminium trolleys, with or without wheels, available for all models h.757 + h.110 mm with wheels.

OPTION



VASCHE PER VUOTO ESTERNO OPZIONALI

// OPTIONAL EXTERNAL VACUUM GN CONTAINERS



Contenitori
GN 1/1 - 1/2
(h.100/150/200)
con coperchio inox opzionali
*Optional containers
GN 1/1 - 1/2
(h.100/150/200)
with s/steel cover*

0-100% VUOTO

// 0-100% VACUUM



Contenitori
GN 1/1 - 1/2 - 1/3
(h.100/150/200)
con coperchio in Tritan opzionali
*Optional containers
GN 1/1 - 1/2 - 1/3
(h.100/150/200)
with cover in Tritan*

0-80% VUOTO

// 0-80% VACUUM



Tutte le macchine sono predisposte di serie per poter utilizzare dei contenitori da vuoto esterno.

All machines models as standard may use external vacuum containers with dedicated programs.

OPTION

LA GAMMA / THE RANGE

EASYVAC

SIRMAN

IL VUOTO NON È MAI STATO COSÌ FACILE
VACUUM HAS NEVER BEEN SO EASY

- La soluzione compatta e affidabile
- Pratico ed intuitivo comando EASY TOUCH con display multilingue
- Particolarmente indicate per il confezionamento di monoporzioni destinate alla cottura in sottovuoto
- Pompe a bagno d'olio per un vuoto estremo fino a 2 Mb (99,9%)

- *The compact, affordable and reliable solution*
- *Practical and intuitive EASY TOUCH control with multilanguage display*
- *Especially dedicated to single portions packing referred to Sous Vide Cooking*
- *Using oil pumps to get the best vacuum up to 2 Mb (99,9%)*



EASYVAC 25



EASYVAC 30



EASYVAC 40

						A	B	C	D	E1	E2	F	G			
	kw	mc/h	mm	mm	mm	mm	mm	mm	mm	mm	mm	mm	mm	kg	mm	kg
Easyvac 25 BX	0.1	1ph	4	260	270x350 h.75	338	565	685	257	340	250	270	708	30	660x420x310	32
Easyvac 30 BX	0.1	1ph	4	310	336x378 h.75	406	580	685	315	335	246	336	731	37	660x740x610	46
Easyvac 40 BX	0.35	1ph	8	410	426x438 h.75	494	637	755	315	395	308	426	810	42.5	660x740x610	51.5
Easyvac 40 DX	0.35	1ph	8	410	426x438 h.75	494	637	755	315	395	308	426	810	42.5	660x740x610	51.5

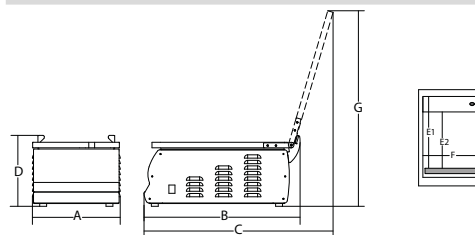

LA GAMMA / THE RANGE

W8 EASY

LA SOLUZIONE DI QUALITA'
SENZA COMPROMESSI

A NO COMPROMISE
QUALITY SOLUTION

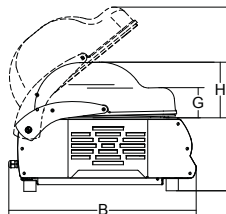
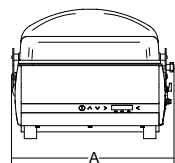

	⚡	⚙️	⏪	☰	⬆️	A	B	C	D	E	F	G	H	⚖️	📦	📦
W8 EASY	kw		mc/h	mm	mm	mm	mm	mm	mm	mm	mm	mm	mm	kg	mm	kg
W8 30 Easy DX	0.35	1ph	8	310	340x360 h.160	402	525	408	587	334	340	95	170	38	720x570x770	48
W8 30 Easy BX	0.35	1ph	8	310	340x360 h.160	402	525	408	587	334	340	95	170	38	720x570x770	48
W8 30 Easy DX 12	0.45	1ph	12	310	340x360 h.160	402	525	408	587	334	340	95	170	38	720x570x770	48
W8 40 Easy DX 12	0.45	1ph	12	410	430x410 h.170	493	585	422	630	390	430	99	180	54	760x640x770	64
W8 40 Easy DX	0.75	1ph	21	410	430x410 h.170	493	585	422	630	390	430	99	180	56	760x640x770	66
W8 40 Easy BX	0.75	1ph	21	410	430x410 h.170	493	585	422	630	390	430	99	180	56	760x640x770	66
W8 50 Easy DX	0.75	1ph	21	510	545x460 h.190	609	640	420	605	430	540	90	210	70	840x870x750	86
W8 50 Easy BX	0.75	1ph	21	510	545x460 h.190	609	640	420	605	430	540	90	210	70	840x870x750	86



W8 30 EASY



W8 40 EASY



W8 50 EASY

LA GAMMA / THE RANGE

W8 TOP



**LA SODDISFAZIONE DI PARTIRE
ULTIMI E ARRIVARE PRIMI**

*THE BENCHMARK IN INNOVATION
AND PERFORMANCE*



W8 TOP 40



W8 TOP 50

	⚡	🔌	📏	📏	⬆️	A	B	C	D	E	F	G	H	👤	📦	📦
W8 TOP																
W8 Top 30 DX	0.35	1ph	8	310	340x360 h.160	402	525	408	587	334	340	95	170	38	720x570x770	48
W8 Top 30 BX	0.35	1ph	8	310	340x360 h.160	402	525	408	587	334	340	95	170	38	720x570x770	48
W8 Top 30 DX 12	0.45	1ph	12	310	340x360 h.160	402	525	408	587	334	340	95	170	38	720x570x770	48
W8 Top 40 DX	0.75	1ph	21	410	430x410 h.170	493	585	422	630	390	430	99	180	56	760x640x770	66
W8 Top 40 BX	0.75	1ph	21	410	430x410 h.170	493	585	422	630	390	430	99	180	56	760x640x770	66
W8 Top 50 DX	0.75	1ph	21	510	545x460 h.190	609	640	420	605	430	540	90	210	70	840x870x750	86
W8 Top 50 BX	0.75	1ph	21	510	545x460 h.190	609	640	420	605	430	540	90	210	70	840x870x750	86
W8 Top 50 DX DB	0.75	1ph	21	410x2	545x460 h.190	609	640	420	605	424	428	90	210	75	840x870x750	87
W8 Top 50 BX DB	0.75	1ph	21	410x2	545x460 h.190	609	640	420	605	424	428	90	210	75	840x870x750	87
W8 TOP 70																
W8 Top 70 BX 40 TB	1.1	3ph+N	40	640x1 / 410x2	780x490 h.190	877	630	513	747	424	660	95	200	115	1200x800x720	128
W8 Top 70 BX 40 TB P	1.1	3ph+N	40	640x1 / 410x2	780x490 h.190	877	674	1134	1368	424	660	95	200	167	1200x800x1350	180

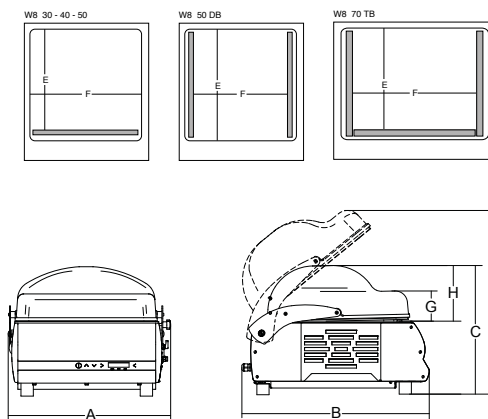

LA GAMMA / THE RANGE

W8 TOP

 SIRMAN

LA SODDISFAZIONE DI PARTIRE ULTIMI E ARRIVARE PRIMI
THE BENCHMARK IN INNOVATION AND PERFORMANCE



W8 TOP 70



W8 TOP 70 TB P

LA GAMMA / THE RANGE

EASYSOFT





















LA SOLUZIONE ALL-IN-ONE PER LA COTTURA SOTTOVUOTO

THE ALL-IN-ONE SOLUTION FOR THE MOST INNOVATIVE COOKING SYSTEM: THE SOUS VIDE



- Space saving solution per una delle tecnologie più dirompenti nella storia della cottura
- Pratica, compatta e veloce soluzione per approfittare velocemente di tutti i vantaggi della cottura sottovuoto (SOUS VIDE)
- Space saving solution for one of the most disruptive cooking technologies in the history of human kind
- Easy, compact and fast solution to get immediately all the advantages of the SousVide Cooking system



																			
	watt	mc/h	mm	mm	mm	lt	lt	mm	mm	mm	mm	mm	mm	mm	mm	mm	kg	mm	kg
Easysoft	100/1.700	1ph	4	260	270x350 h.75	280x400 h.180	19.7	15	695	560	685	257	340	263	264	708	45	740x720x320	48

APP & INDUSTRIA 4.0

Tutti i modelli **W8 EASY TOUCH** e **W8 TOP** sono dotati di chip **WiFi** che permette di collegare la macchina al cloud e di essere gestita tramite pratica **APP**. I numerosi sensori di controllo combinati al sensore di pressione e di temperatura (solo modelli TOP) seguono una logica intelligente che aiuta nella migliore gestione della macchina sia durante l'utilizzo che nella manutenzione.

*All the **W8 EASY TOUCH** and **W8 TOP** models incorporate a WiFi chip to connect the machine to the cloud and to manage the unit through a simple but very complete **APP**. Multiple control sensors combined with the pressure and temperature sensors (only TOP models) are integrated with an intelligent software that helps to get the best from the machine during use and maintenance.*



MADE IN ITALY



www.sirman.com