

# TEOREMA POLIS PW 3 / MC18

## 2P02H06B



## Main Features

- Versatile - Totally Modular and ready to Create, from Pastry making to baking and pizza production!
- 3 tray 600x400mm bakery deck oven with embossed metal baking surface allows the air circulation under the pan,
- 180mm baking chamber opening
- Reaches quickly the set temperature and responds quickly to oven temperature and power settings
- Optional baking surface (bottom) in refractory material Suitable for cooking in pans or directly on the bottom. Stack up to 4 modules so that your oven can grow with your business
- Optional Steam generator can be fitted an any stage to produce High Quality steam.
- Wide range of optional extras available to suit your baking needs
- Control Panel - 20 cooking programs with the possibility to set the cooking time and temperature, top and floor power levels (separately) and vaporisation level (optional).
- The color display and buzzer signal the user when cooking has finished.
- All the programmes can be named for quick and easy control during work.
- There are three functions that are always available to the user:
  - (1) PRE-HEATING, useful for preheating the oven;
  - (2) AUTO-CLEANING, necessary for sanitizing the cooking chamber after long periods of non-use;
  - (3) ECONOMY function - The Economy mode is activated via the control panel and is used to hold the oven temperature while reducing energy power requirements and consumption.
- The control panel also allows you to program the oven to start up twice a day and over the entire week so that you can always have your Teorema Polis PW ready to use.



## AVAILABLE ACCESSORIES

- 2.8 Kw Steam generator
- Baking surface in refractory material
- Prover 95cm (suits up to 2 units)
- Prover 71cm (suits up to 3 units)
- Stand 125cm (single unit stand)
- Stand 95cm (double unit stand)
- Stand 71cm (triple unit stand)
- Stand 40cm (quadruple unit stand)
- Exhaust Hood
- 40cm single bread batch frame
- 60cm single bread batch frame
- Pan holding trolley for base

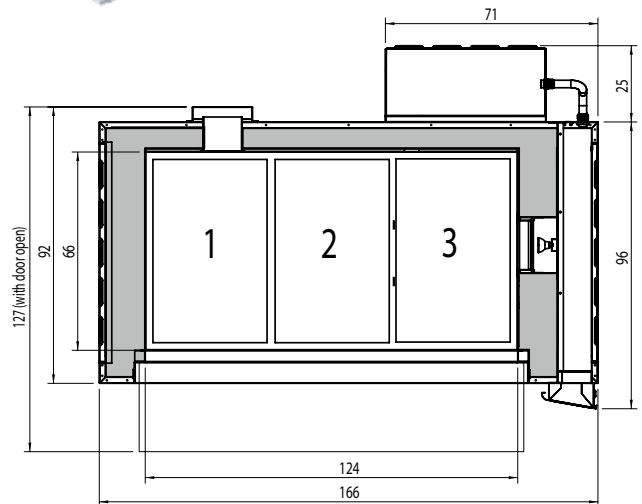

## SPECIFICATIONS

Voltage	400Vac 3N 50/60Hz - 11.3Amps
Max Power	7,800 Watts
Weight	207 kg
Working Temp.	400°C
Max Humidity	95% without condensation
Capacity	3 x 600x400mm Baking Trays
Chamber Height	180 mm
Cable Length	2 meters
Warranty	4 Year Warranty (2 yr Labour 4 yr Parts)

## DIMENSIONS

External Width	1660mm	Internal Width	1240mm
External Depth	1010mm	Internal Depth	660mm
External Height	360mm	Internal Height	180mm



Phone: 1800 183 818 Email: support@thegoodlady.com.au  
 Website: www.thegoodlady.com.au

# TEOREMA POLIS PW 3 / MC18

## FRONT

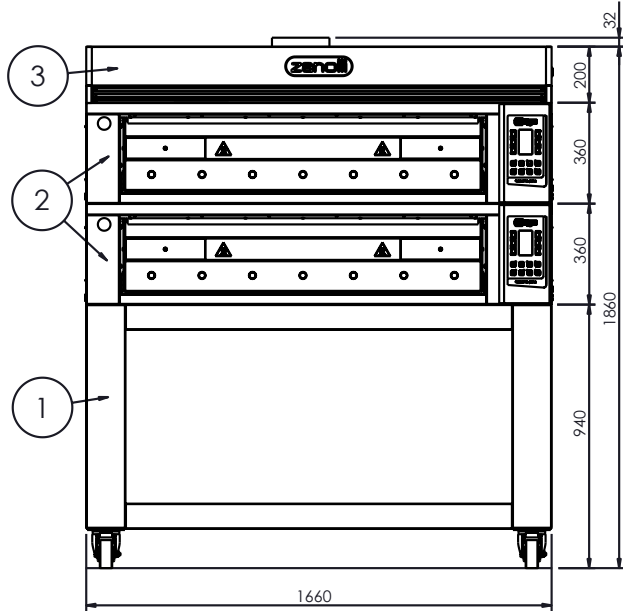

## SIDE

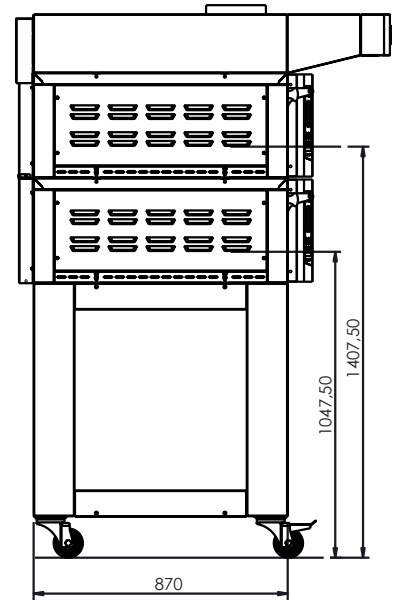

Num. articolo / Item num.	Quantità / Quantity	Descrizione / Description	Potenza / Power
11		BASAMENTO/BASE	-
22		T POLIS PW 3 UT18	15.6 kW
31		TOP	-

## REAR

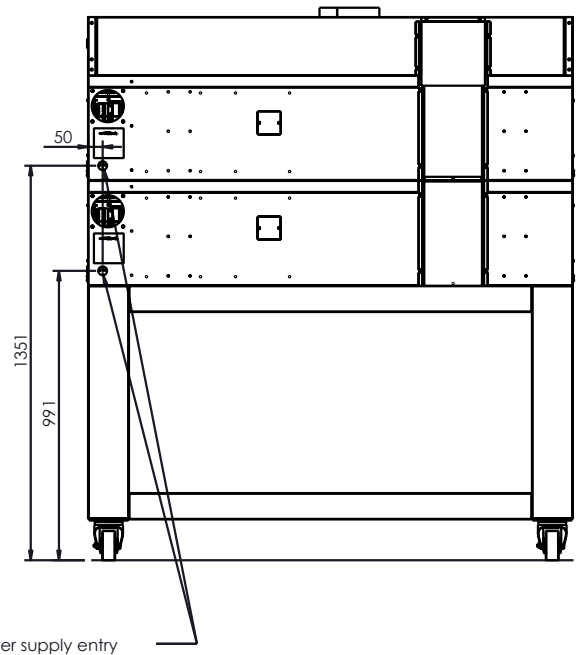

## TOP

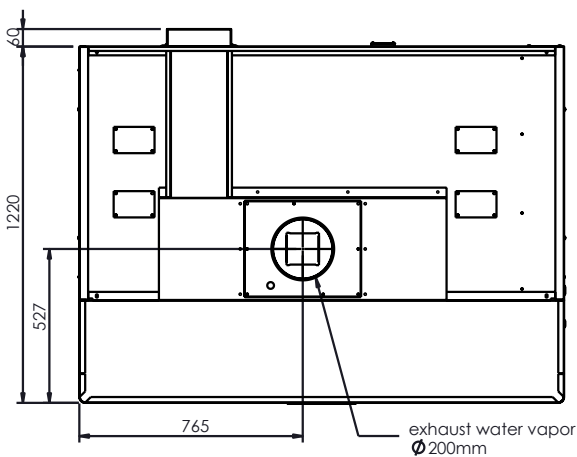

We reserve the right to alter specifications without notice.



THE  
GOOD  
LADY

Phone: 1800 183 818 Email: support@thegoodlady.com.au  
Website: www.thegoodlady.com.au

# TEOREMA POLIS PW 3 / MC18 / MC30

## FRONT

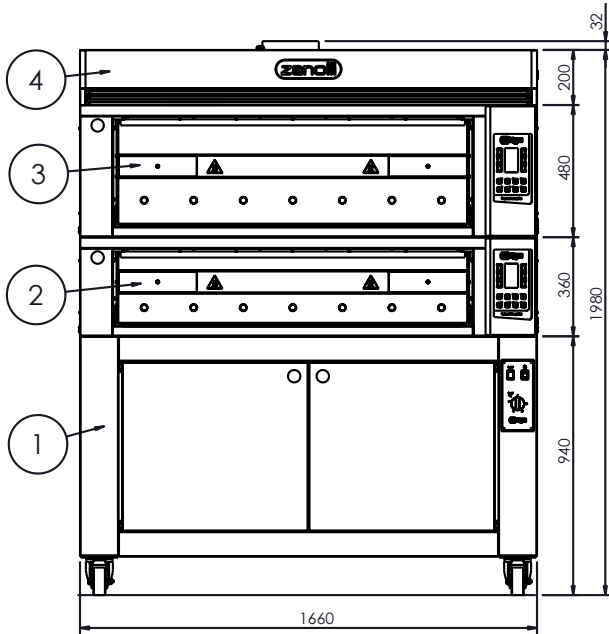

Num. articolo	Quantità	Descrizione	Potenza
11		CELLA LIEV.	1.5 kW
21		T POLIS PW 3 UT18	7.8 kW
31		T POLIS PW 3 UT30	7.8 kW
41		CAPPA ASP.	0.3 kW
52		VAPORIZZATORE	5.6 kW

## SIDE

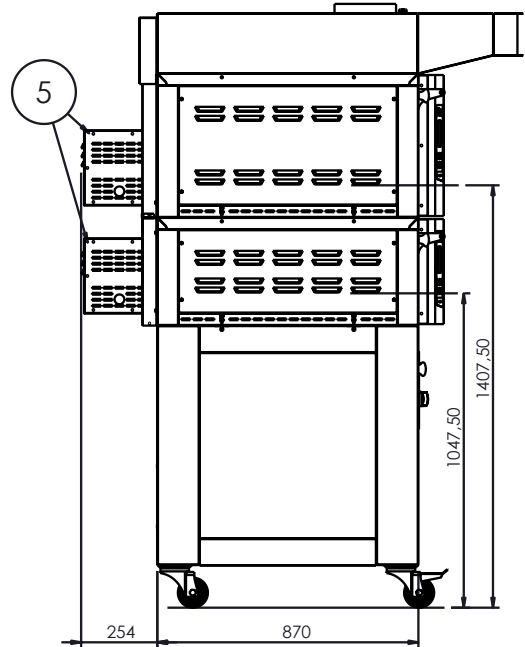

## REAR

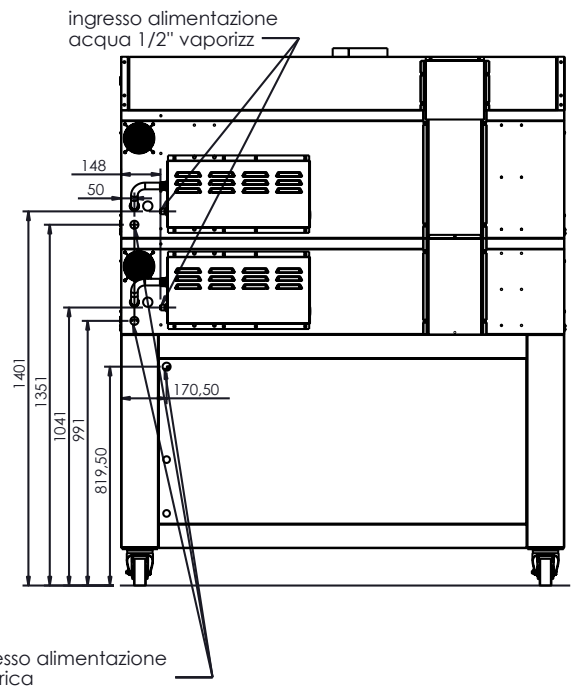

## TOP

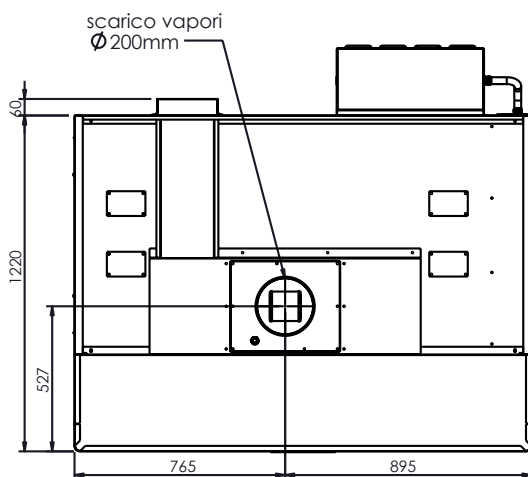

We reserve the right to alter specifications without notice.



THE  
GOOD  
LADY

Phone: 1800 183 818 Email: support@thegoodlady.com.au  
Website: www.thegoodlady.com.au

# TEOREMA POLIS PW 3 - ACCESSORIES

## SINGLE UNIT STAND

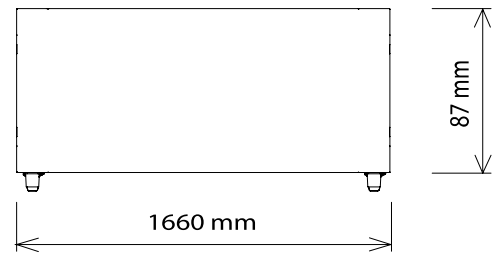
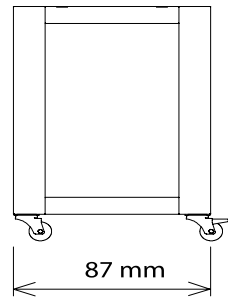
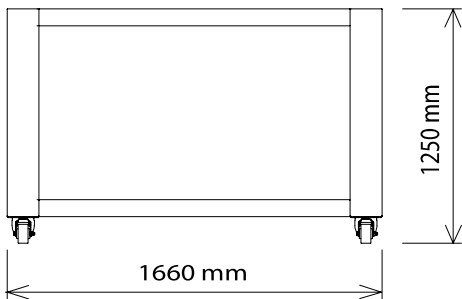

## DOUBLE UNIT STAND

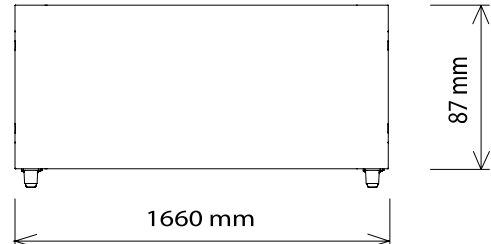
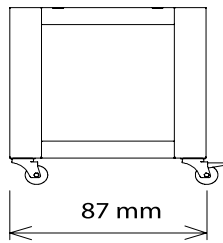
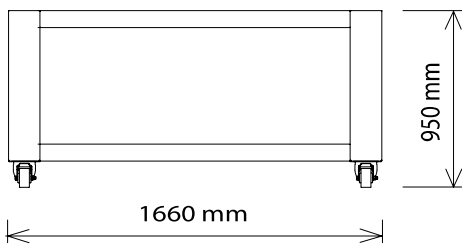

## TRIPLE UNIT STAND

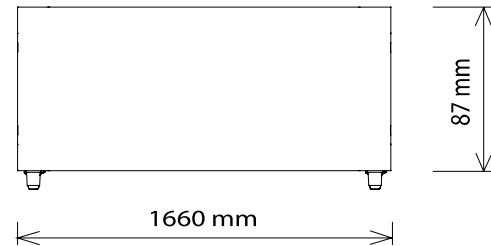
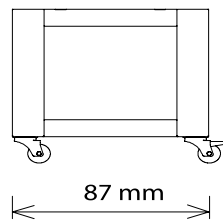
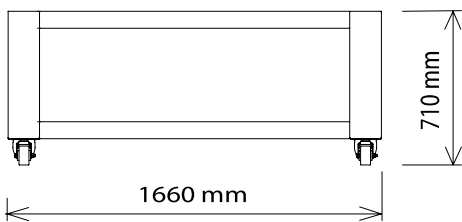

## FOUR UNIT STAND

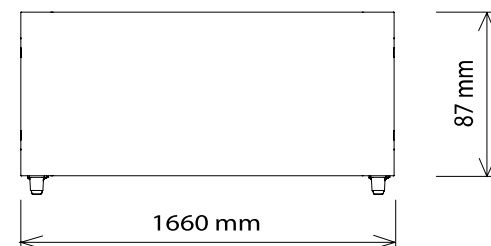
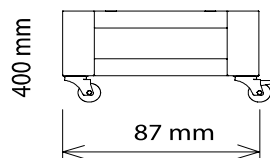
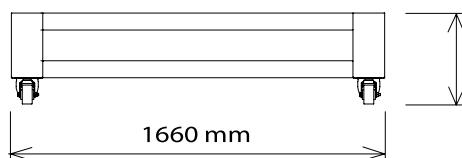

We reserve the right to alter specifications without notice.

# TEOREMA POLIS PW 3 - ACCESSORIES

## EXHAUST HOOD

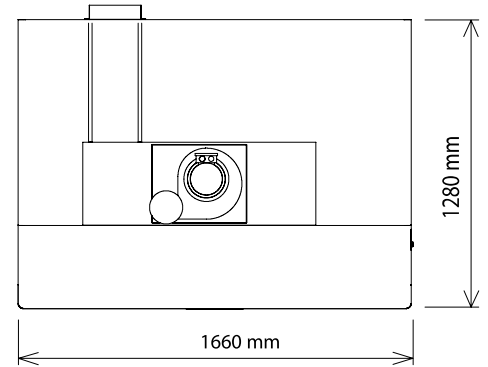
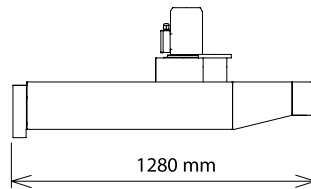
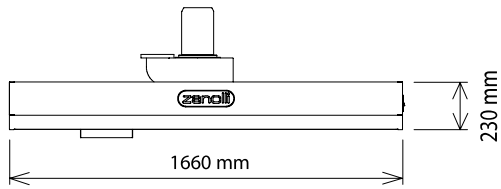

## 95 CM PROVER (SUITS UP TO 2 UNITS)

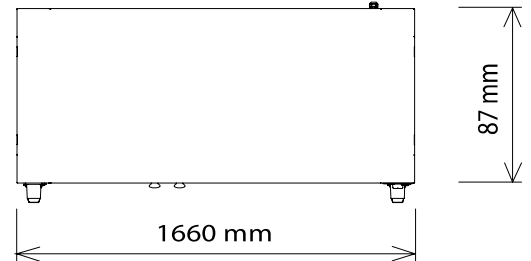
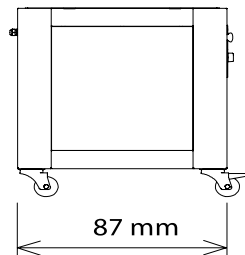
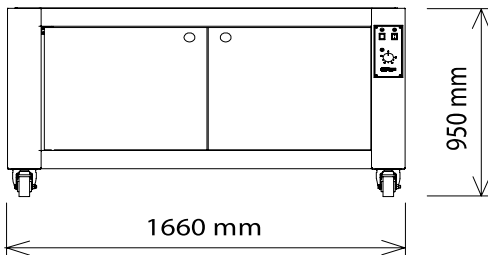

## 71 CM PROVER (SUITS UP TO 3 UNITS)

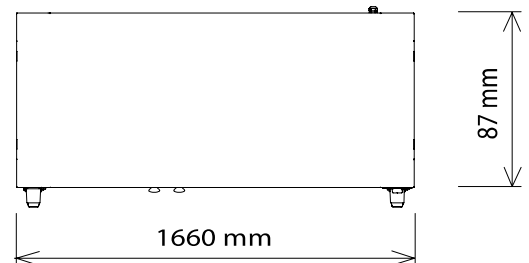
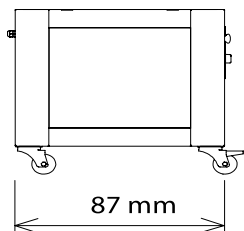
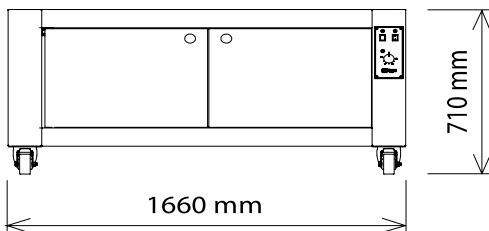

We reserve the right to alter specifications without notice.



Phone: 1800 183 818 Email: [support@thegoodlady.com.au](mailto:support@thegoodlady.com.au)  
Website: [www.thegoodlady.com.au](http://www.thegoodlady.com.au)